

Prosilica GT 1920

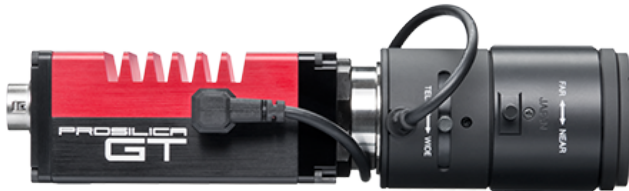

- Versatile temperature range for extreme environments
- IEEE 1588 PTP
- Power over Ethernet
- P-Iris and DC-Iris lens control

2.8 Megapixel industrial camera for extreme environments

Prosilica GT1920 is a 2.8 Megapixel camera with a GigE Vision compliant Gigabit Ethernet port and Hirose I/O port. Prosilica GT1920 is offered in both monochrome and color models. This camera incorporates a high quality Sony ICX674 CCD sensor with EXview HAD II technology that provides high sensitivity, near IR response, low noise, anti-blooming, and excellent image quality. At full resolution, this camera runs 40.7 frames per second. With a smaller region of interest, higher frame rates are possible. It is a rugged camera designed to operate in extreme environments and fluctuating lighting conditions. This camera offers Precise iris lens control allowing users to fix the aperture size to optimize depth of field, exposure, and gain without the need for additional control elements. By default monochrome models ship with no optical filter and color models ship with an IRC30 IR cut filter.

Benefits and features:

- Monochrome (GT1920) and color (GT1920C) models
- GigE Vision interface with Power over Ethernet
- Screw mount RJ45 Ethernet connector for secure operation in industrial environments
- Supports cable lengths up to 100 meters (CAT-5e or CAT-6)
- Trigger over Ethernet (ToE) Action Commands allow for a single cable solution to reduce system costs
- Comprehensive I/O functionality for simplified system integration
- Popular C-Mount lens mount
- Easy camera mounting via standard M3 threads or optional tripod adapter
- Easy software integration with Allied Vision's [Vimba SDK](#) and compatibility to the most popular [third party image-processing libraries](#).
- Defect pixel column masking feature with the Load Defect Tables tool that allows you to manage a user defined defective pixel list to match your application and optimize the life cycle of the camera.

Options:

- Available with CS-Mount, F-Mount, EF-Mount Birger, M42-Mount
- Available with IR cut filter or protection glass

See the [Modular Concept](#) for lens mount and optical filters options. See the [Customization and OEM Solutions](#) webpage for additional options.

Specifications

Prosilica GT	1920
インターフェイス	IEEE 802.3 1000BASE-T, IEEE 802.3af (PoE)
解像度	1936 (H) × 1456 (V)
センサー	Sony ICX674
Sensor type	CCD Progressive
センサーサイズ	Type 2/3
ピクセルサイズ	4.54 μm × 4.54 μm
レンズマウント (標準搭載)	C-Mount
フレームレート (フル解像度)	40.7 fps
ADC	14 bit
Image buffer (RAM)	128 MByte
Imaging performance	HEADLINE-IP

Imaging performance data is based on the evaluation methods in the EMVA 1288 Release 3.1 standard for characterization of image sensors and cameras. Measurements are typical values for monochrome models measured at full resolution without optical filter. Contact Sales or AE for more information.

Quantum efficiency at 529 nm	62 %
Temporal dark noise	8.2 e ⁻
Saturation capacity	14600 e ⁻
Dynamic range	64.5 dB
Absolute sensitivity threshold	8.7 e ⁻

Output

Bit depth	12/14 Bit
ビデオフォーマット(Mono)	Mono8, Mono12, Mono12Packed, Mono14
ビデオフォーマット(YUV)	YUV411Packed, YUV422Packed, YUV444Packed
ビデオフォーマット(RGB)	RGB8Packed, BGR8Packed, RGBA8Packed, BGRA8Packed
ビデオフォーマット(Raw)	BayerGR8, BayerGR12, BayerRG12Packed
General purpose inputs/outputs (GPIOs)	
TTL I/Os	1 input, 2 outputs

Prosilica GT	1920
Opto-isolated I/Os	1 input, 2 outputs
RS232	1
Operating conditions/dimensions	
Operating temperature	-20 °C to +60 °C ambient (without condensation)
Power requirements (DC)	7 to 25 VDC AUX or 802.3at Type 1 PoE
消費電力	4.9 W at 12 VDC; 6.0 W PoE
Mass	224 g
Body dimensions (L × W × H in mm)	92 × 53.3 × 33 (including connectors)
Regulations	CE: 2014/30/EU (EMC), 2011/65/EU, including amendment 2015/863/EU (RoHS); FCC Class A; CAN ICES-003 Issue 4/5

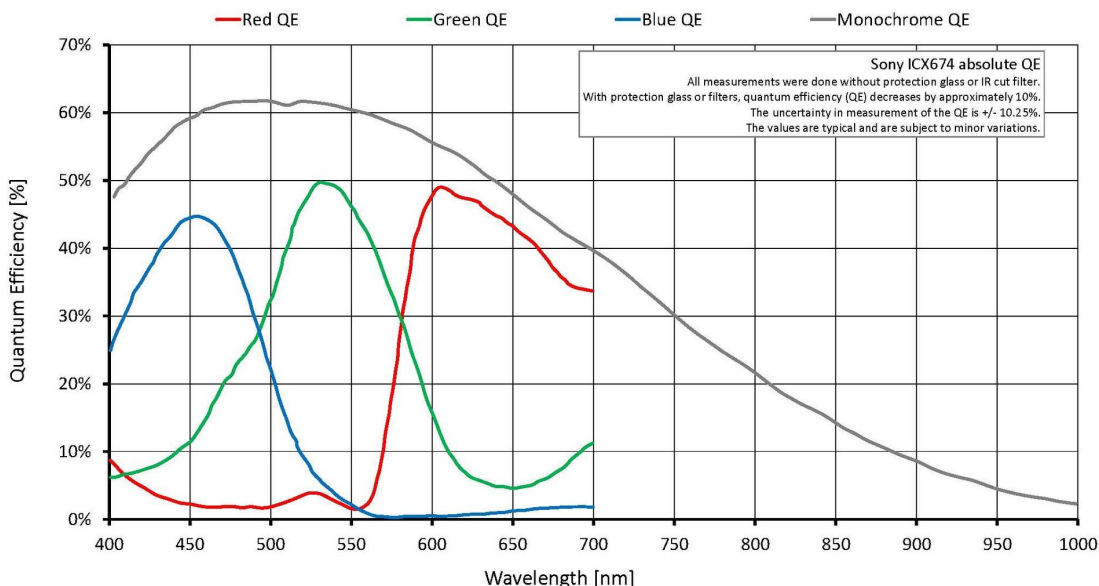

Features

Image optimization features:

- Auto gain (manual gain control: 0 to 33 dB)
- Auto exposure (manual exposure control: 10 μs to 26.8 s)
- Auto white balance (GT1920C only)
- Binning (horizontal and vertical)
- Color correction, hue, saturation (GT1920C only)
- Decimation X/Y
- Defect pixel column masking (user defined with Load Defect Tables tool)



- Gamma correction
- Three look-up tables (LUTs)
- Region of interest (ROI), separate ROI for auto features
- Reverse X/Y

Camera control features:

- P-Iris and DC-Iris lens control
- Event channel
- Image chunk data
- IEEE 1588 Precision Time Protocol (PTP)
- RS232
- Storable user sets
- StreamBytesPerSecond (bandwidth control)
- Stream hold
- Sync out modes: Trigger ready, input, exposing, readout, imaging, strobe, GPO
- Tap mode switchable in Vimba Viewer 2.0 or later (four-tap, one-tap)
- Temperature monitoring (main board and sensor board)
- Trigger over Ethernet (ToE) Action Commands

Technical drawing

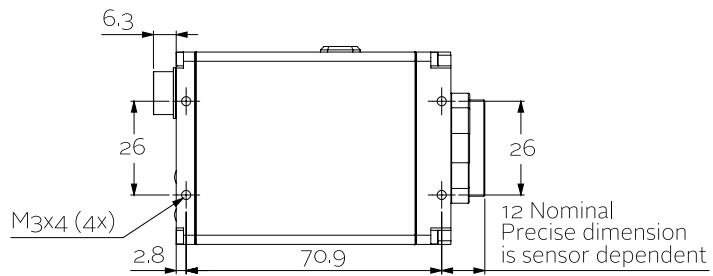
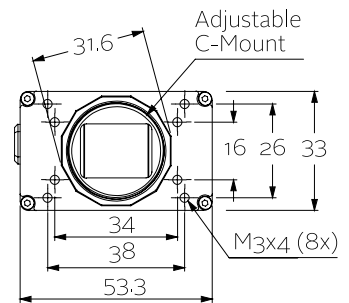
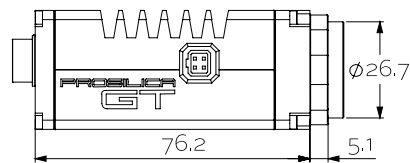
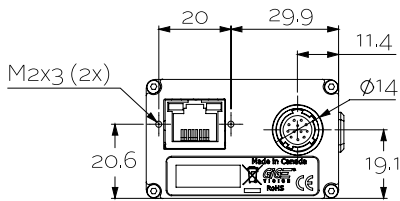
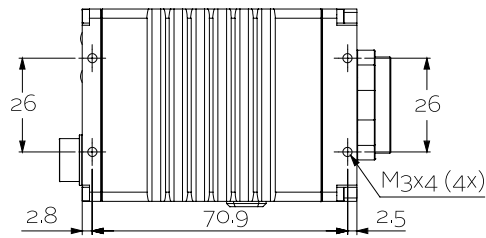



Applications

Prosilica GT1920 is ideal for a wide range of applications including:

- Outdoor imaging
- Traffic imaging and Intelligent Traffic Systems (ITS)
- Public security and surveillance
- Industrial inspection
- Machine vision
- Military and space applications