



- Latest CMOS sensor
- High frame rates
- Ultra-compact
- Extensively tested accessories

Small and powerful

Mako U - Ultra-compact USB3 Vision cameras

Mako U-029 with ON Semi PYTHON 300 runs 550.0 frames per second at 0.3 MP resolution.

The Mako U is an attractively priced camera in a compact rugged industrial housing. It's equipped with an USB3 Vision-compliant interface technology to enable a reliable connection to your host system and image processing solution. Basic functionalities, including screw mount connectors and multiple I/Os, facilitate straightforward system integration. Mako cameras are equipped with high-quality CMOS sensors to support the realization of future-oriented applications.

Mako U monochrome USB3 Vision cameras have the same compact housing with a form factor of 49.5 x 29 x 29 mm. Screw locks ensure a safe electrical connection even in harsh industrial environments.

Every model is powered over the USB interface and has opto-isolated I/Os. The GPIOs give Mako U maximum flexibility to adapt to specific needs. The two non-isolated GPIO lines are TTL-based and programmable as input or output.

Options:

- Various IR cut/pass filters, protection glass, various lens mounts

Specifications

Interface	USB3 Vision
Resolution	640 (H) × 480 (V)
Sensor	ON Semi PYTHON 300
Sensor type	CMOS
Sensor size	Type 1/4
Pixel size	4.8 μm × 4.8 μm
Lens mount (default)	C-Mount, CS-Mount
Max. frame rate at full resolution	550 fps
ADC	10 Bit
Image buffer (RAM)	128 MByte

Imaging performance

Imaging performance data is based on the evaluation methods in the EMVA 1288 Release 3.1 standard for characterization of image sensors and cameras. Measurements are typical values for monochrome models measured at full resolution without optical filter. Contact Sales or AE for more information.

Quantum efficiency at 529 nm	50 %
Temporal dark noise	8.2 e ⁻
Saturation capacity	6300 e ⁻
Dynamic range	57.1 dB
Absolute sensitivity threshold	9.0 e ⁻

Output

Bit depth	8/10 Bit
Monochrome pixel formats	Mono8, Mono10p

General purpose inputs/outputs (GPIOs)

TTL I/Os	2 programmable GPIOs
Opto-isolated I/Os	1 input, 1 output

Operating conditions/dimensions

Operating temperature	+5 °C to +45 °C (housing temperature)
Power requirements (DC)	Power over USB 3.0
Power consumption	2.7 W at 5 VDC
Mass	60 g
Body dimensions (L × W × H in mm)	49.5 × 29 × 29 (including connectors)

Quantum efficiency

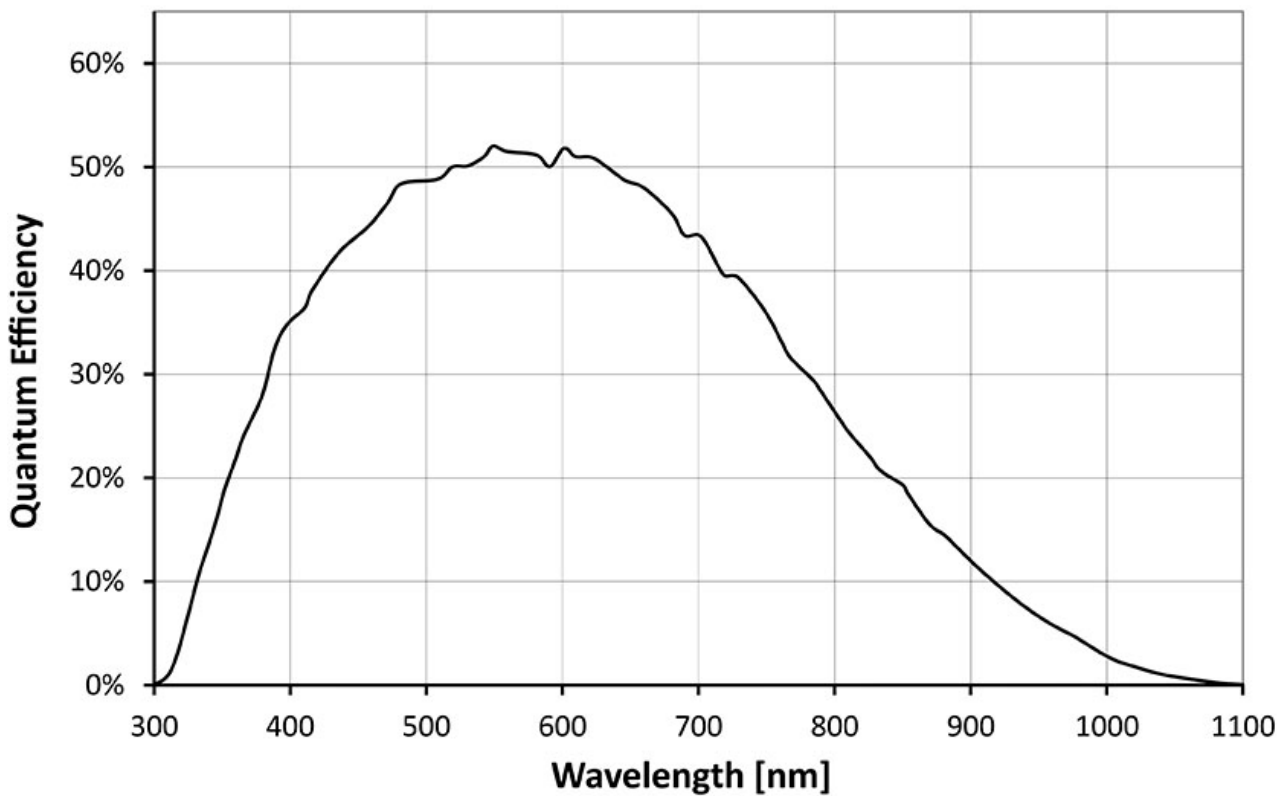

Features

- Defect pixel correction (on/off)
- Fixed pattern noise correction (on/off)
- Region of interest (ROI)
- Gain (manual control, 0 to 20 dB)
- Exposure (manual control, 44.2 μ s to 1.4 s)
- Gamma correction
- Reverse X
- DeviceLinkThroughputLimit (easy bandwidth control)
- Sync out modes: Waiting for a trigger, exposing, readout, imaging
- Storable user sets

Technical drawing

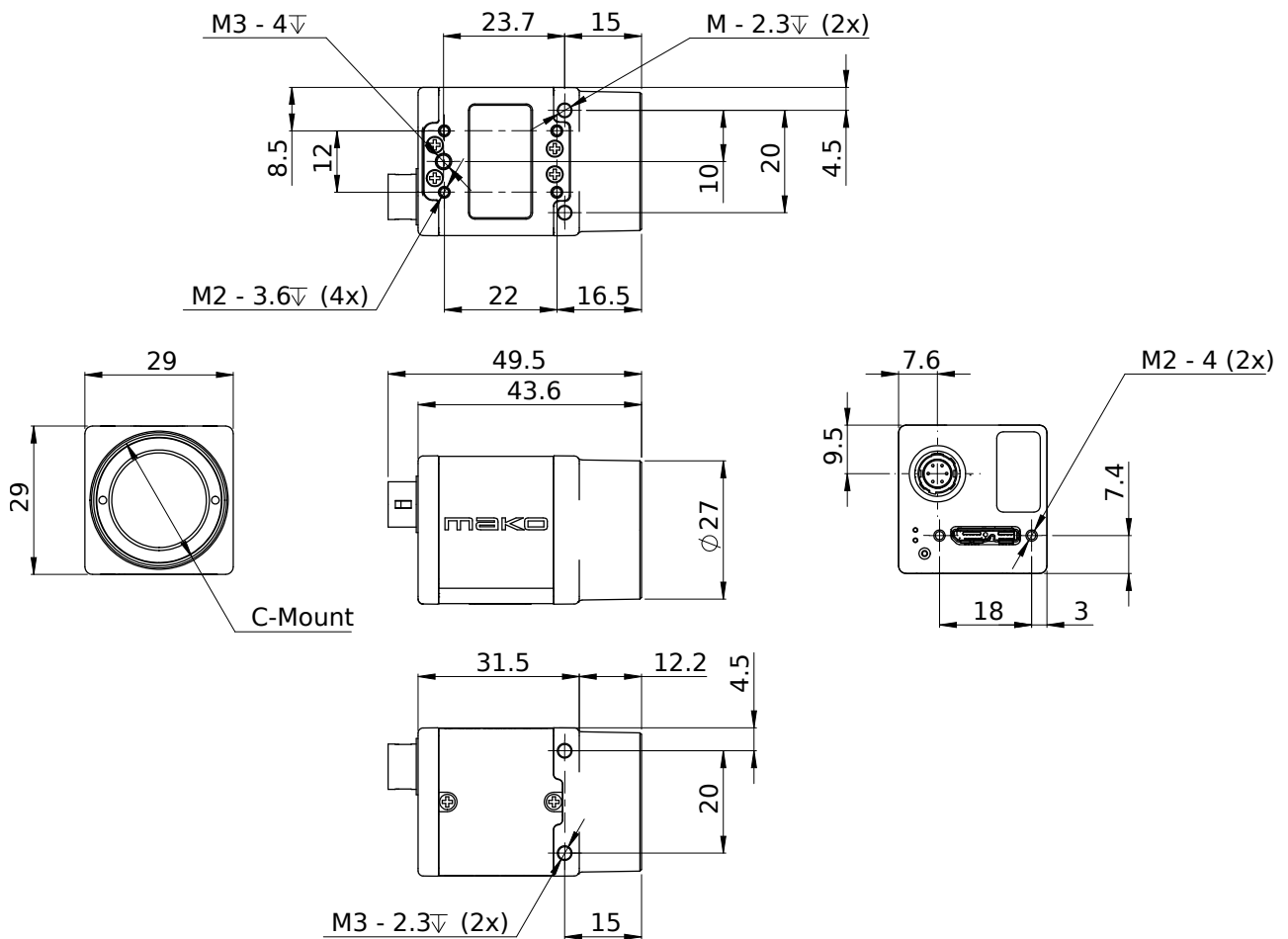

Applications

The Mako U is an inexpensive USB 3.0 camera with a compact housing. USB 3.0 technology has lower latency and jitter times with less CPU load than other camera interfaces.

Typical applications for Mako U cameras:

- Machine vision
- Quality control
- Inspection, surveillance
- Industrial imaging