

Alvium GM2

Alvium GM2-1620



Alvium GM2-1620 innovative GMSL2 camera with Sony IMX542 CMOS global shutter sensor provides industrial performance for cost effective embedded applications.

General

Model:	Alvium GM2-1620
Product series:	Alvium GM2
Status:	Available

Sensor

Sensor type:	Area scan
Chroma:	Mono or Color
Spectrum:	Visible
Spectral range:	300 nm to 1100 nm
Resolution:	5,328 × 3,040 (16.20 MP)
Sensor model:	Sony IMX542
Sensor architecture (material):	CMOS
Shutter type(s):	Global Shutter
Sensor size:	17.6 mm ø (Type 1.1)
Pixel size:	2.74 µm × 2.74 µm

Pixel formats

Sensor bit depth:	12-bit
Monochrome pixel formats:	Mono8, Mono10, Mono10p, Mono12, Mono12p, RAW8, RAW10, RAW12, GREY, Y10, Y12
YUV pixel formats:	YCbCr411_8_CbYYCrYY, YCbCr422_8_CbYCrY, YCbCr8_CbYCr, YUV422 8-bit, UYVY

Pixel formats

RGB pixel formats:	RGB8 (default), BGR8, RGB888 (default), RGB3
Bayer pixel formats:	BayerGR8, BayerGR10, BayerGR10p, BayerGR12, BayerGR12p

Imaging performance

Quantum efficiency @ 529 nm:	68 %
------------------------------	------

Timing and gain

Max. frame rate:	Mainly depends on hardware and register settings.
------------------	---

I/Os and power

Non-isolated lines:	2 programmable GPIOs
I/O connector:	Coax, STP
Power supply:	5 VDC over MIPI CSI-2
Power consumption:	Value for the integrated serializer adds to CSI-2 model value.

Operating conditions

Operating temperature (housing):	-20 °C to 65 °C (housing)
----------------------------------	---------------------------

Mechanical properties

Body dimensions (L x W x H in mm):	41 × 29 × 29
Lens mount(s):	C-Mount, CS-Mount
Weight:	70 g

On-board memory and FPGA

Image buffer (RAM):	256 KByte
Non-volatile memory (Flash):	1024 KByte

Interfaces

Digital interface:	GMSL2, based on MIPI CSI-2, up to 4 lanes
--------------------	---

Quantum Efficiency



Alvium FP3/GM2 C-Mount Coax

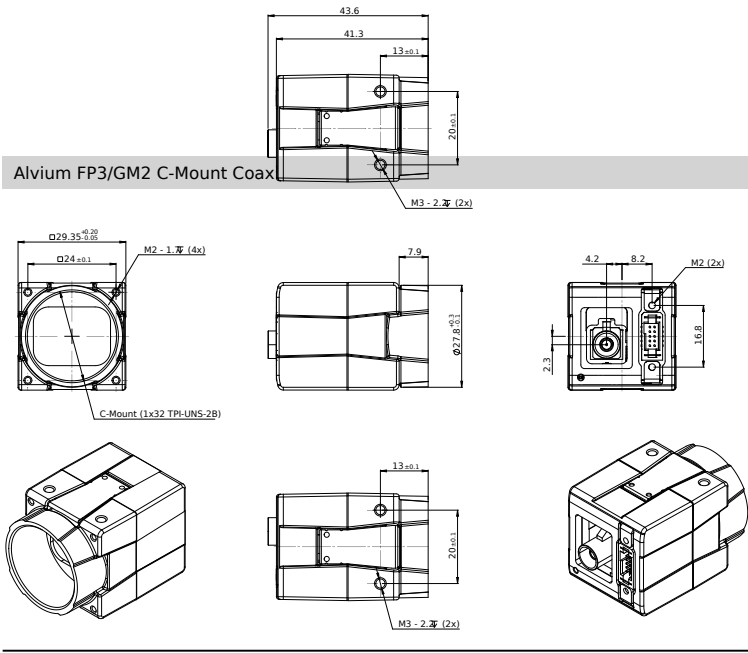

Alvium FP3/GM2 C-Mount STP

