

Alvium FP3

Alvium FP3-507



Alvium FP3-507 innovative FPD-Link III camera with Sony IMX264 CMOS global shutter sensor provides industrial performance for cost effective embedded applications.

General

Model:	Alvium FP3-507
Product series:	Alvium FP3
Status:	Available

Sensor

Sensor type:	Area scan
Chroma:	Mono or Color
Spectrum:	Visible
Spectral range:	300 nm to 1100 nm
Resolution:	2,464 × 2,056 (5.10 MP)
Sensor model:	Sony IMX264
Shutter type(s):	Global Shutter
Sensor size:	12.75 mm \varnothing (Type 2/3)
Pixel size:	3.45 μm × 3.45 μm

Pixel formats

Monochrome pixel formats:	GREY, RAW10, RAW12, RAW8, Y10, Y12
YUV pixel formats:	UYVY, YCbCr411_8_CbYYCrYY, YCbCr422_8_CbYCrY, YCbCr8_CbYCr, YUV422 8-bit
RGB pixel formats:	BGR8, RGB3, RGB8 (default), RGB888 (default)
Bayer pixel formats:	BayerGR10, BayerGR10p, BayerGR12, BayerGR12p, BayerGR8

Imaging performance

Quantum efficiency @ 529 nm: 64 %

Timing and gain

Max. frame rate: Mainly depends on hardware and register settings.

Exposure time: 28 μ s to 10 s

Gain: 0.0 dB to 48.0 dB

I/Os and power

Non-isolated lines: 2 programmable GPIOs

I/O connector: Coax, STP

Power supply: 5 VDC over MIPI CSI-2

Power consumption: Value for the integrated serializer adds to CSI-2 model value.

Operating conditions

Operating temperature (housing): -20 °C to 65 °C (housing)

Mechanical properties

Body dimensions (L x W x H in mm): 41 × 29 × 29

Lens mount(s): C-Mount, CS-Mount

Weight: 70 g

On-board memory and FPGA

Image buffer (RAM): 256 KByte

Non-volatile memory (Flash): 1024 KByte

Interfaces

Digital interface: FPD-Link III, based on MIPI CSI-2, up to 4 lanes

Quantum Efficiency

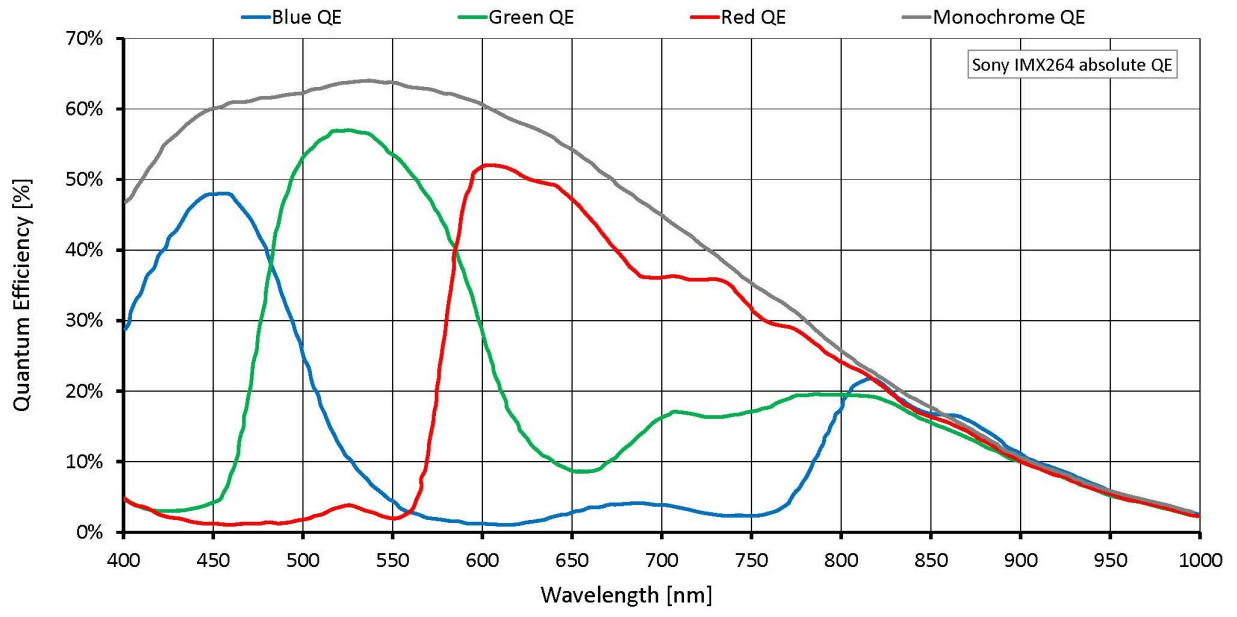

Alvium FP3/GM2 C-Mount Coax

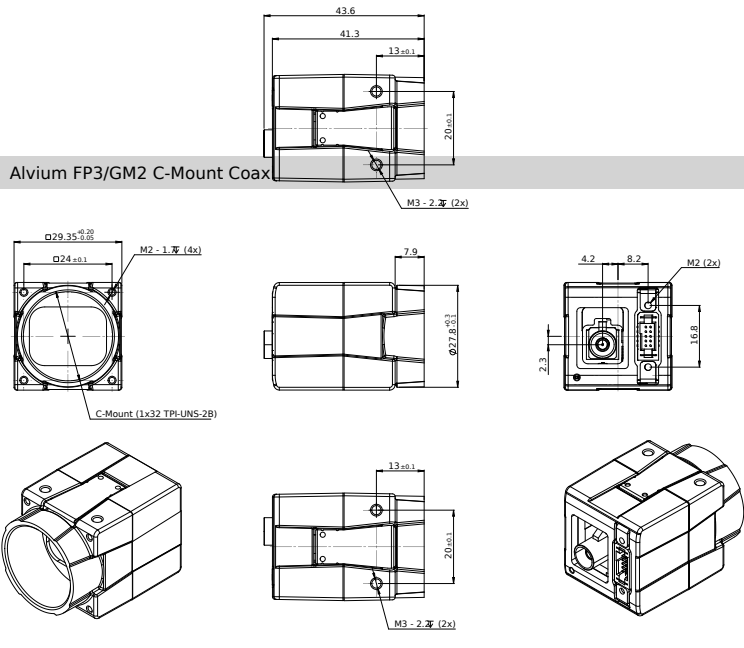

Alvium FP3/GM2 C-Mount STP

