

Prosilica GT 1920

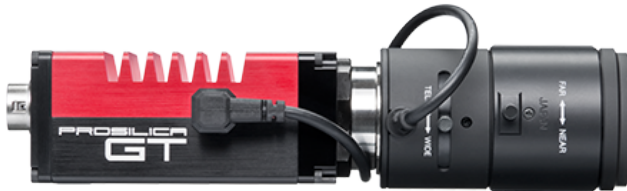

- Versatile temperature range for extreme environments
- PTP
- PoE
- P-Iris and DC-Iris lens control

基本描述

2.82 Megapixel industrial camera for extreme environments - fast frame rates
 Prosilica GT1920 is a 2.82 Megapixel camera with a Gigabit Ethernet interface (GigE Vision®). GT1920 incorporates Sony ICX674 CCD sensor that provides high sensitivity, near IR response, low noise, anti-blooming, and excellent image quality. GT1920 is a rugged camera designed to operate in extreme environments and fluctuating lighting conditions. It offers Precise iris lens control allowing users to fix the aperture size to optimize depth of field, exposure and gain without the need for additional control elements.

Options:

- Various IR cut/pass filters and lens mounts

性能参数

Prosilica GT	1920
接口	IEEE 802.3 1000BASE-T, IEEE 802.3af (PoE)
分辨率	1936 × 1456
传感器	Sony ICX674
传感器类型	CCD Progressive
像元尺寸	4.54 μm x 4.54 μm
镜头接口	C-Mount
分辨率下最高帧速	40.7 fps
ADC	14 bit
缓存 (RAM)	128 MByte
非易失性内存 (Flash)	1024 KByte (for selected models only)
	输出
Bit位数	14 (mono) - 12 (color) bit
黑白模式	Mono8, Mono12, Mono12Packed, Mono14

Prosilica GT	1920
彩色模式 YUV	YUV411Packed, YUV422Packed, YUV444Packed
彩色模式RGB	RGB8Packed, BGR8Packed, RGBA8Packed, BGRA8Packed
原始模式	BayerGR8, BayerGR12, BayerRG12Packed
通用输入输出(GPIOs)	
TTL I/Os	1 input, 2 outputs
光耦 I/Os	1 input, 2 outputs
RS-232	1
工作条件/尺寸	
工作温度	-20 °C to +60 °C ambient (without condensation)
电源要求 (DC)	7 to 25 VDC; PoE
功耗 (@12 V)	4.9 W @ 12 VDC; 6.0 W PoE
重量	224 g
尺寸(L × W × H in mm)	92 × 53.3 × 33 (including connectors, w/o tripod and lens)
符合规范	CE, RoHS, REACH, WEEE, FCC, ICES

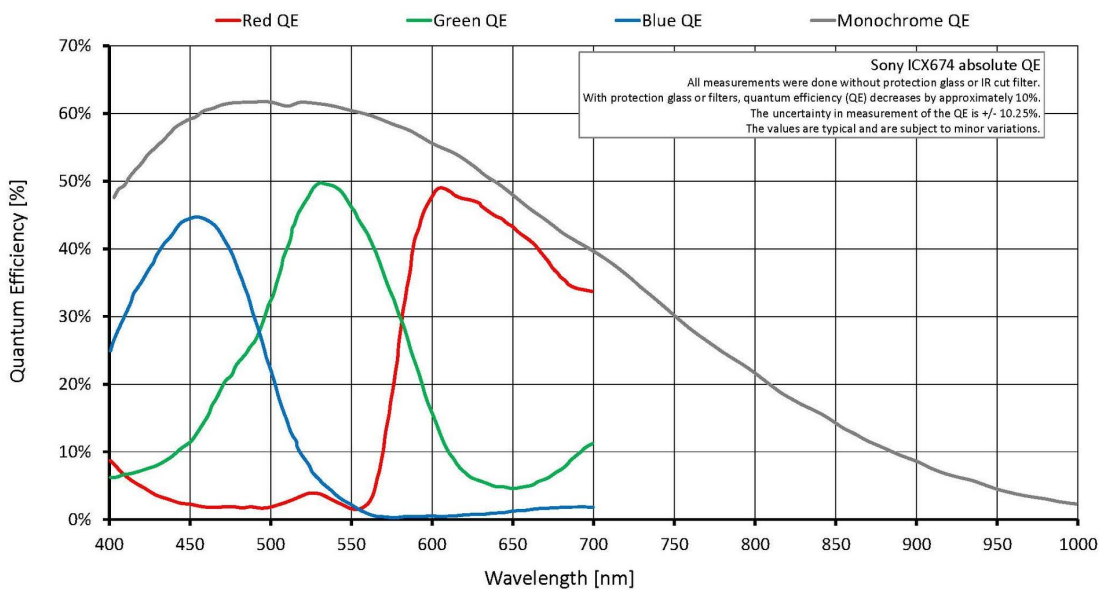

特性

Image optimization features:

- Auto gain (manual gain control: 0 to 33 dB)
- Auto exposure (manual exposure control: 10 μ s to 26.8 s)



- Auto white balance
- Binning (horizontal and vertical)
- Color correction, hue, saturation (color models only)
- Column defect masking
- Decimation X/Y
- Gamma correction
- Look-up tables (LUTs)
- Region of interest (ROI), separate ROI for auto features
- Reverse X/Y

Camera control features:

- P-Iris and DC-Iris lens control
- Event channel
- Image chunk data
- IEEE 1588 Precision Time Protocol (PTP)
- RS232
- Storable user sets
- StreamBytesPerSecond (easy bandwidth control)
- StreamHold
- Sync out modes: Trigger ready, input, exposing, readout, imaging, strobe, GPO
- Tap mode switchable in Vimba Viewer 2.0 or later (four-tap, one-tap)
- Temperature monitoring (main board and sensor board)
- Trigger over Ethernet (ToE) Action Commands
- Non-volatile memory 1024 KByte (for selected models only)

外形尺寸

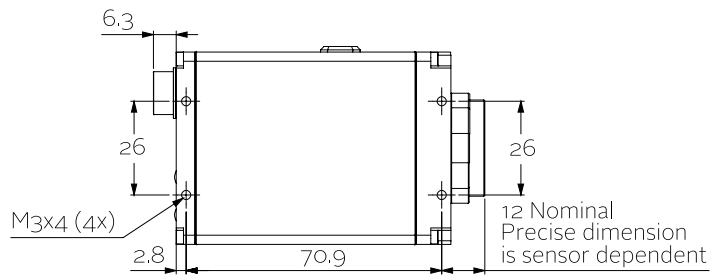
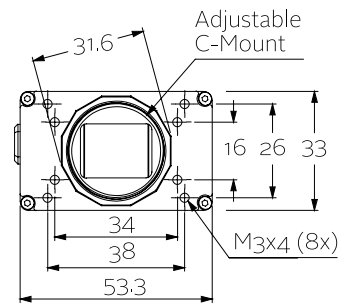
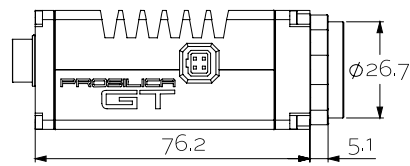
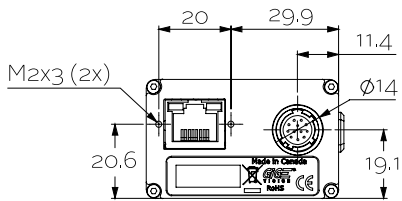
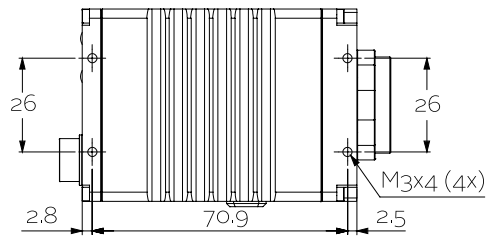



应用场景

Prosilica GT1920 is ideal for a wide range of applications including:

- Outdoor imaging
- Traffic imaging / ITS
- Public security and surveillance
- Industrial inspection
- Machine vision
- Military and space applications